

RGBW

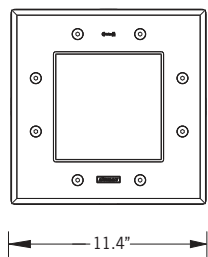

29w LED 1299 Lumens
 IP67 • Suitable For Wet Locations
 IK10 • Impact Resistant (Vandal Resistant)
 Weight 19.7 lbs

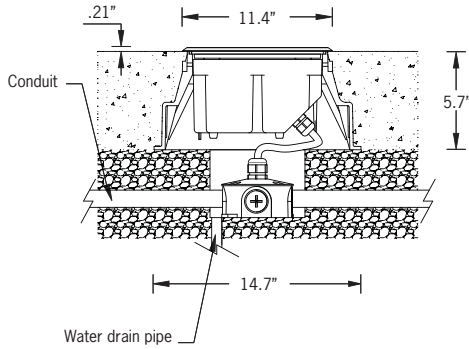

Construction

Frame Options

Extended Frame: Slightly raised & protruding over the edge of the recessing box, used to cover irregular finish around the recessing box e.g cut tiles.

Flush Frame: Installed flush with the floor surface, typically used with poured concrete or precision cut tiles.

Aluminum

Less than 0.1% copper content - Marine Grade 6060 extruded & LM6 Aluminum High Pressure die casting provides excellent mechanical strength, clean detailed product lines and excellent heat dissipation.

Memory Retentive -Silicon Gasket

Provided with special injection molded "fit for purpose" long life high temperature memory retentive silicon gaskets. Maintains the gaskets exact profile and seal over years of use and compression.

Thermal management

LM6 Aluminum is used for its excellent mechanical strength and thermal dissipation properties in low and high ambient temperatures. The superior thermal heat sink design by Ligman used in conjunction with the driver, controls thermals below critical temperature range to ensure maximum luminous flux output, as well as providing long LED service life and ensuring less than 10% lumen depreciation at 50,000 hours.

Surge Suppression

Standard 10kv surge suppressor provided with all fixtures.

BUG Rating

B3 - U5 - G5

Hardware

Provided Hardware is Marine grade 316 Stainless steel.

Anti Seize Screw Holes

Tapped holes are infused with a special anti seize compound designed to prevent seizure of threaded connections, due to electrolysis from heat, corrosive atmospheres and moisture.

Crystal Clear Low Iron Glass Lens

Provided with tempered, impact resistant crystal clear low iron glass ensuring no green glass tinge.

Optics & LED

Precise optic design provides exceptional light control and precise distribution of light. LED CRI > 80

Lumen - Maintenance Life

L80 /B10 at 50,000 hours (This means that at least 90% of the LED still achieve 80% of their

Professional technical inground lighting solutions.

Sophisticated and expansive; single, twin-lamp, white and RGBW DMX, with 7 beam types.

A top range of small shallow inground uplights with a round or square profile available with an extended or flush mounted frame. The fixture is manufactured with a marine grade 316 stainless steel front ring and is designed for use in shopping and pedestrian areas for illuminating building facades, columns, squares, parks, gardens, sculptures, flag poles and trees.

The adjustable high powered LED's in conjunction with high efficiency optics provides focused beam distributions to suit most design applications.

The tapered high density polyethylene inground recessing box is provided with securing lugs on each side to allow the installer to properly secure the box in place thereby stopping it from moving during the concrete pour procedure.

These securing lugs can also be used to secure the base to wood support beams and working in conjunction with the tapered recessing box will prevent the fixture from lifting when installed in dirt. The housing also has two shoulders to prevent fixture rotation when used in drive over applications.

The Kios is available with a non-slip ADA glass. This glass is infused with a specialized non-slip finish across the entire surface of the lens making this non-slip option the best in the industry.

To ensure efficient drainage, gravel must be used to a depth of 17" and a width of 12" beneath the housing, and should also be placed around the luminaire.











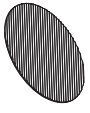

An animated video can be viewed on the Ligman website to show proper Kios installation procedure to assist contractors and ensure a problem-free installation.

Power is provided to the integral control gear through a specially developed anti-wicking PG13.5 watertight cable gland and 2ft of outdoor submersible #18/5 SOOW 600V power cable. Clear or frosted tempered 0.6" thick glass.

2.5 ton maximum load is transferred by the housing to the foundation. Vehicles with pneumatic tires can drive over the luminaire but the speed must not exceed 30mph. The distance between the floodlight and the illuminated surface should be at least 1.6'.

The high power LED option is available in RGBW for the Kios 5, 6, 7 & 8.

Additional Options (Consult Factory For Pricing)

 A61612 Anti Slip Lens	 CRL Concentric Ring Louvre	 AGL Anti Glare Louvre	 LSL Linear Spread Lens
 A68391 STICK-DE3 [Nicolaudie]	 A64491 TPC Touch Screen and Controller DMX [Pharos]	 A64591 POE Connect [Pharos]	
 A64691 TPC Touch Screen and Controller DMX 2 [Pharos]	 A64791 RDM DMX Splitter [Pharos]	 A65191 TPC Touch Panel Station [Pharos]	 A65391 EDN Ethernet Data Node [Pharos]
 A66991 LPCX Lighting Playback Controller X [Pharos]	 A64991 CLOUD [Pharos]		

UKI-60588

KIOS 6 Ingrade Extended Frame

PROJECT		DATE	
----------------	--	-------------	--

QUANTITY		TYPE		NOTE	
-----------------	--	-------------	--	-------------	--

ORDERING EXAMPLE || UKI-60588-29w - N - RGBW30- 120/277v

UKI-60588				
	LAMP	BEAM	RGBW COLOR	VOLTAGE
	29w LED 1299 Lumens	N - Narrow 21° M - Medium 35° E - Elliptical 26°x48°	RGBW30 - Warm White 3200K RGBW40 - Neutral White 4000K RGBW65 - Cool White 6850K	120/277v Other - Specify

ADDITIONAL OPTIONS

- | | |
|---------------------------|------------------------------|
| F - Frosted Lens | A61312 - Anti Slip Lens |
| DIM - 0-10v Dimming | CRL - Concentric Ring Louvre |
| NAT - Natatorium Rated | ACL - Anti Glare Louvre |
| TORQ - Torque Screwdriver | LSL - Linear Spread Lens |

NOTE: A proper torque screwdriver set at 30 inch pounds must be used to tighten all screws securing the housing to the recessing box, as well as fastening the body and frame. Please specify TORQ in the additional options section to order a proper torque screwdriver for installation.

- | | |
|-------------------------------|---------------------------------|
| A68391 - STICK-DE3 | A64791 - RDM DMX Splitter |
| A64491 - TPC + DMX Controller | A65191 - TPC Touch Panel |
| A64591 - POE Connect | A65391 - EDN Ethernet Data Node |
| A64691 - TPC + DMX 2 | A66991 - LPCX Lighting Playback |
| | A64991 - CLOUD |



RGBW DMX/RDM Control

RGBW control requires precise communication between lighting fixtures and IP-based systems. To manage Red, Green, Blue, and White diodes effectively, each fixture must be pre-addressed to ensure accurate individual or grouped control.

Ligman's Engineered Approach

Ligman offers a structured, performance-driven methodology for RGBW system design and deployment.

Fixture Addressing

- Default: Fixtures are factory-programmed with the same DMX address unless otherwise specified.
- Issue: Identical addresses cause all fixtures to respond as one—changing colors simultaneously.

Solution: Assign unique DMX addresses to each fixture during programming or via RDM tools to enable independent or grouped control.

Termination Resistors

To prevent signal interference (crosstalk) between fixtures:

- Ligman supplies 120-ohm termination resistors.
- Install inside the last fixture or at its J-Box. – (Resistor will be factory installed on most fixtures, Some will require installation Onsite Depend-ent Upon Fixture and Type.) - Connect between DMX+ and DMX- signal lines.

System Design Guidelines

Fixture Count

- On 3 or More Fixtures: A terminating resistor is installed at the end of the run.

On 5 or More Fixtures: Ligman may request additional layout details to validate system integrity.

Fixtures with Dual DMX Addresses require more DMX channels, reducing the number of fixtures per run. (Refer to technical drawings for specifics.)

- Maximum Distance Without Booster: 984 ft (300 m) from the controller.

Beyond This Limit: DMX/RDM splitters or boosters are required.

Custom Layouts

For non-standard RGBW configurations, Ligman requires:

- Fixture quantity per run
- Distance between fixtures
- Total cable length from controller to last fixture

This ensures:

- Reliable DMX signal transmission
- Proper use of termination resistors and splitters

Compliance with fixture and distance limitations

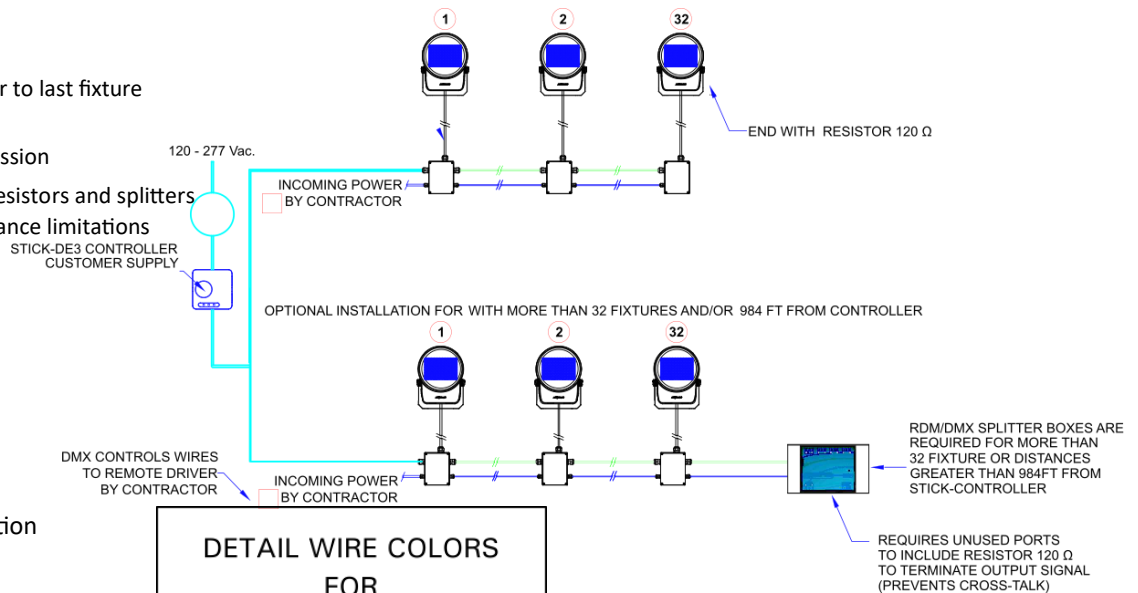

Single Fixture Connection
Or
Final Fixture Connection

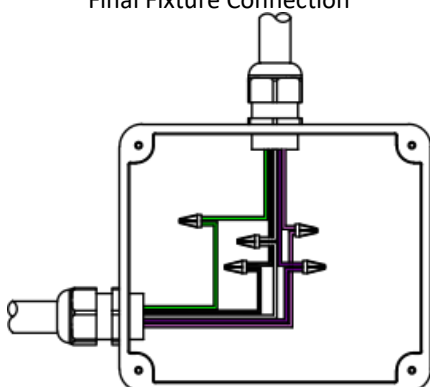

Looping to Multiple Fixtures
Example Fixture#1,2,3,4,ect.

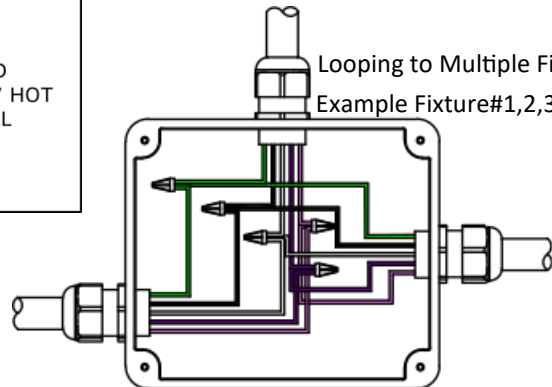



STICK-DE3

The feature rich lighting controller has been designed to provide a control solution for the most demanding of projects, whilst maintaining an easy to use panel of touch sensitive buttons. The controller integrates a graphical color screen allowing scene photos to be displayed. Easily view the selected zone, scene name and design without the need to navigate through complex menus. Change the speed, color and dimmer using the circular palette.

The lighting levels, color and effects can be programmed from a PC, Mac, Android, iPad or iPhone using the included software.



Stick-DE3



RDM DMX Splitters

The RDM (Remote Device Management) is a 4 port DMX512 Splitter compatible with the RDM standard to provide DMX output to luminaires and other devices. DMX splitters are an essential requirement for most control systems, allowing multiple separate cable runs from a single DMX output and ensuring electrical isolation.

A64791

DMX Splitter / Booster - Remote IP65 Box

DMX/RDM Splitter, within an IP65 box with 1 channel output, is a digital signal distributor is used with DMX512-A and ANSI E1.20 RDM. 1-port, DMX/RDM isolated splitter engineered to take any architectural, commercial, or entertainment project to the next level. Multiple DMX/RDM Splitter can be chained together to create as many outputs as you need.

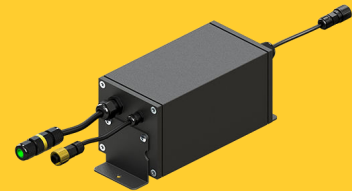

RDM - DMX Repeater

The RDM (Remote Device Management) is a 4 port DMX512 Splitter compatible with the RDM standard to provide DMX output to luminaires and other devices. DMX splitters are an essential requirement for most control systems, allowing multiple separate cable runs from a single DMX output and ensuring electrical isolation.

Kios Product Family



Kios 1

- UKI-60445-6w-317lm
- UKI-60485-8w-658lm
- UKI-60486-7w-600lm
- UKI-60791-12w-1086lm



Kios 2

- UKI-60465-6w-317lm
- UKI-60505-8w-658lm
- UKI-60506-7w-600lm
- UKI-60751-12w-1086lm



Kios 3

- UKI-60455-6w-317lm
- UKI-60495-8w-658lm
- UKI-60496-7w-600lm
- UKI-60741-12w-1086lm



Kios 4

- UKI-60475-6w-317lm
- UKI-60515-8w-658lm
- UKI-60516-7w-600lm
- UKI-60761-12w-1086lm



Kios 5

- UKI-60568-29w RGBW-1299lm
- UKI-60771-30w-3160lm
- UKI-60775-33w-3320lm



Kios 6

- UKI-60588-29w RGBW-1299lm
- UKI-60791-30w-3160lm
- UKI-60795-33w-3320lm



Kios 7

- UKI-60578-29w RGBW-1299lm
- UKI-60781-30w-3160lm
- UKI-60785-33w-3320lm



Kios 8

- UKI-60598-29w RGBW-1299lm
- UKI-60801-30w-3160lm
- UKI-60805-33w-3320lm



Kios 9

- UKI-60647-25w-2739lm



Kios 10

- UKI-60667-25w-2739lm



Kios 11

- UKI-60657-25w-2739lm



Kios 12

- UKI-60677-25w-2739lm